

Potrzebne dodatkowo
przy montażu

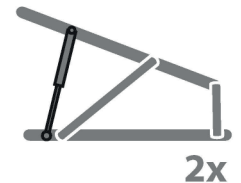

Elementy łóżka

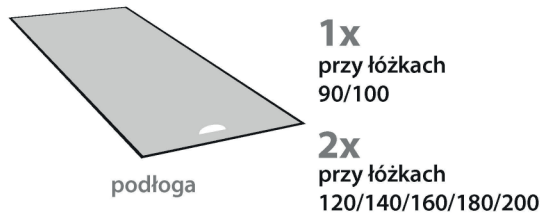
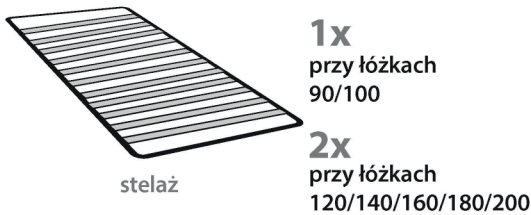

Elementy łączące

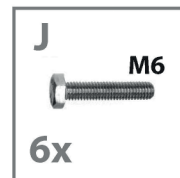
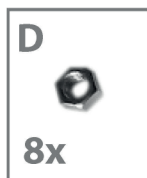
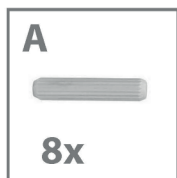

kołek drewniany

wzmocnienie
stalowe



Podczas skręcania łóżka zachowujemy najwyższą staranność, a wszystkie śruby dokręcamy z wyczuwaniem do momentu kiedy zaczynają stwarzać wyczuwalny opór.

1

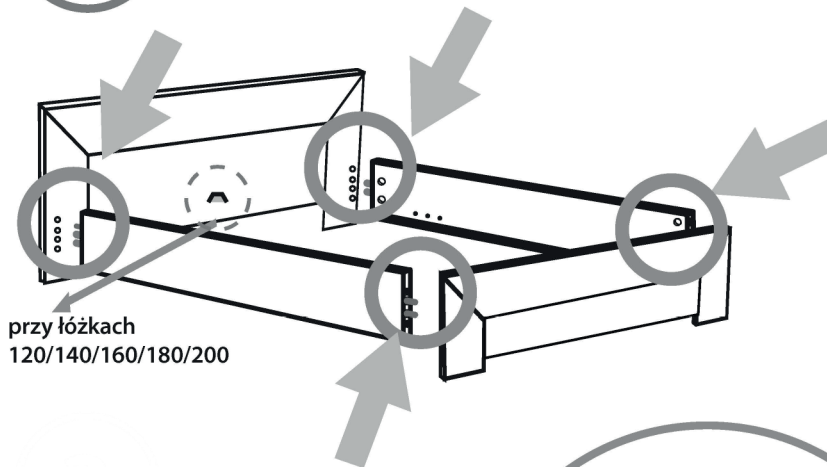

przy łóżkach
120/140/160/180/200

2

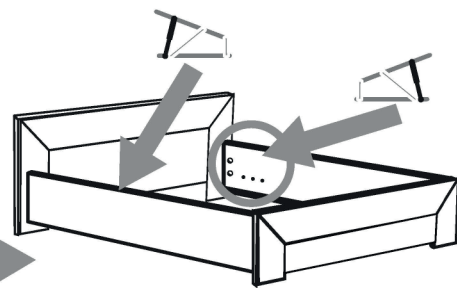
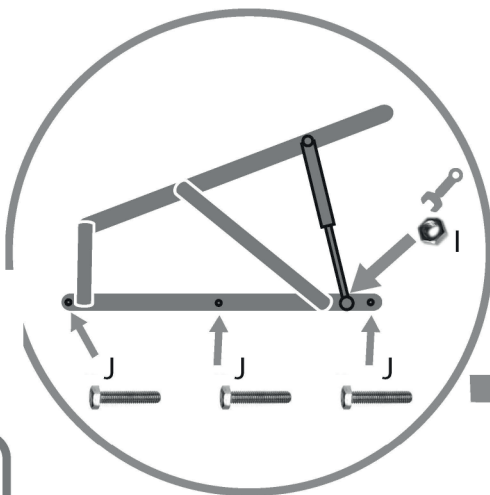

W łóżkach z otwieraniem
bocznymi otworami do
mocowania trójkąta
z siłownikiem znajdują się
w zagłowie i zanóżku

3

Stelaż Multi Box
Montaż zgodnie z instrukcją
znajdująca się wew. opakowania stelaża

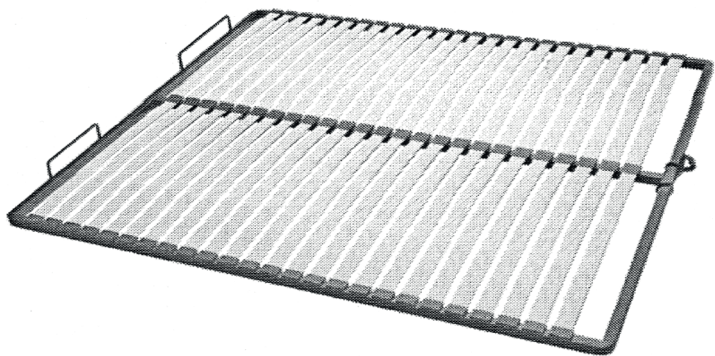

4

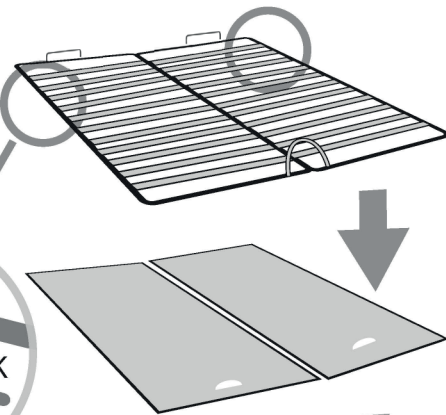

przy łóżkach 120/140/160/180/200

