

Potrzebne dodatkowo  
przy montażu

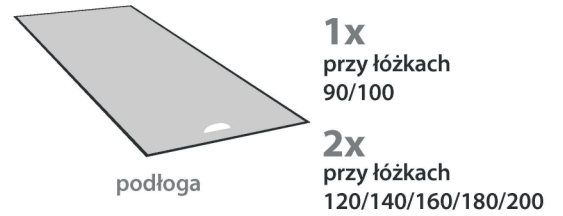

### Elementy łóżka

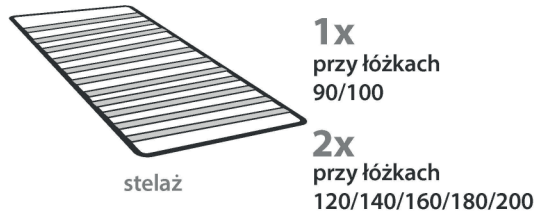
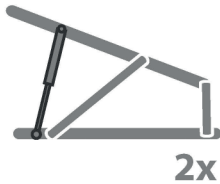
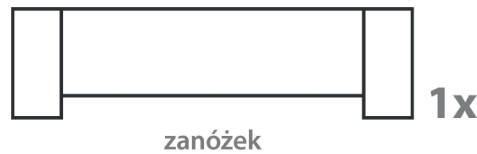
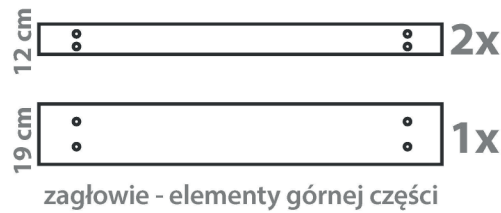
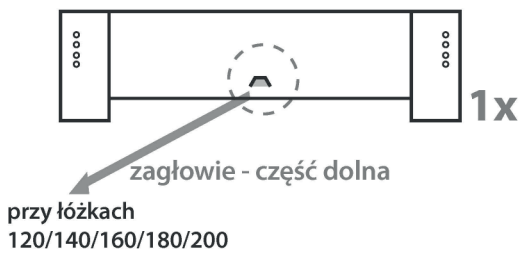

### Elementy łączące

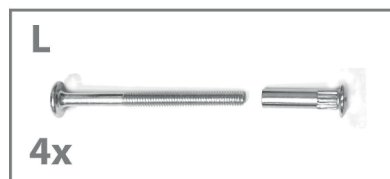
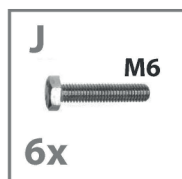
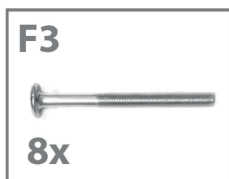
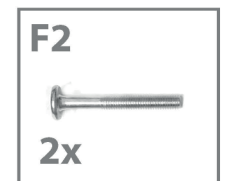
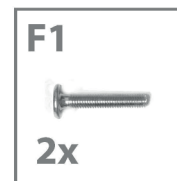
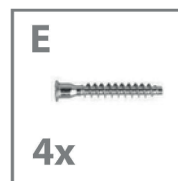
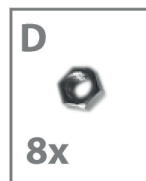
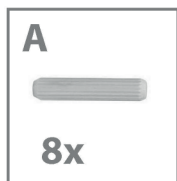

Podczas skręcania łóżka zachowujemy najwyższą staranność, a wszystkie śruby dokręcamy z wyciżeniem do momentu kiedy zaczynają stwarzać wyczuwalny opór.

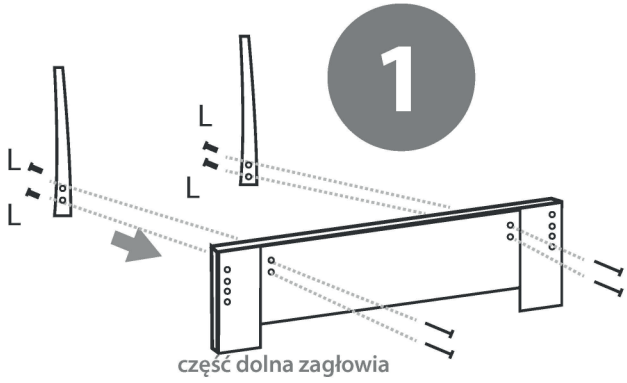

1

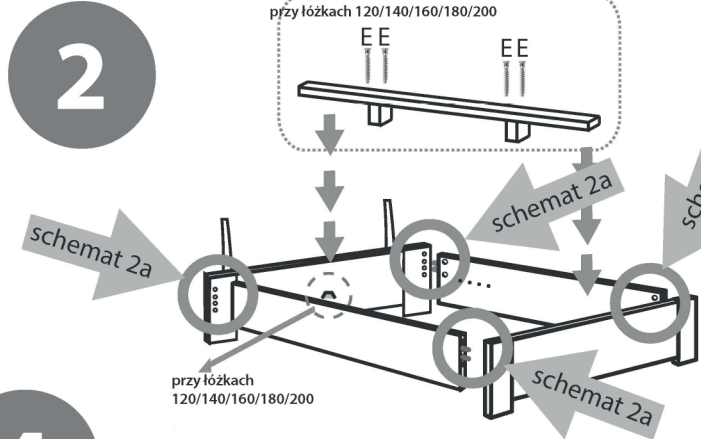
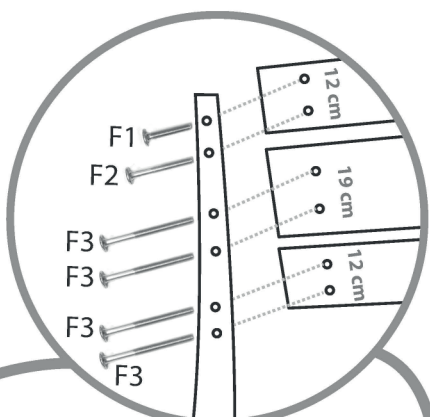
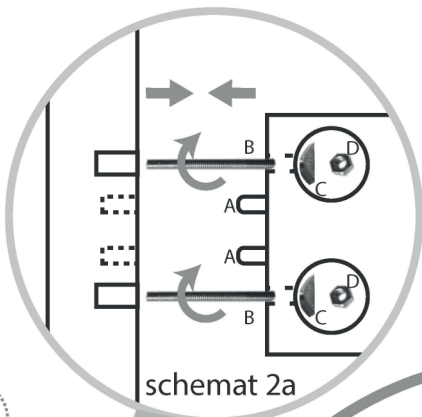

2

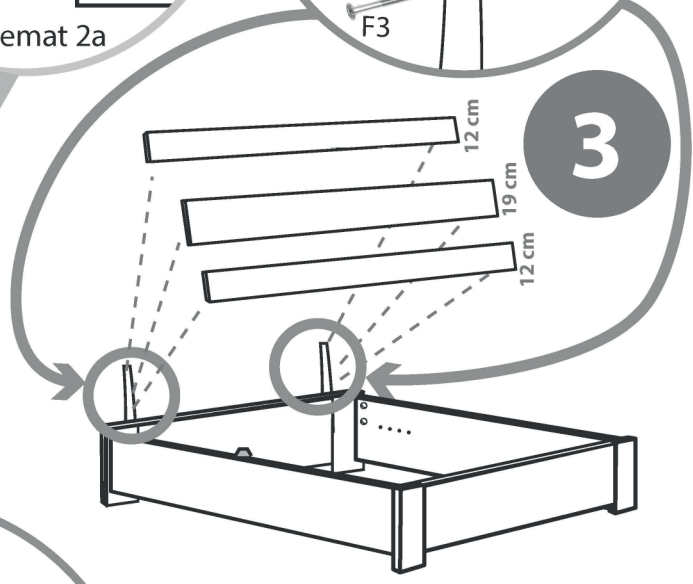

3

4

! W łóżkach z otwieraniem bocznymi otworami do mocowania trójkąta z siłownikiem znajdują się w zagłowiu i zanózku

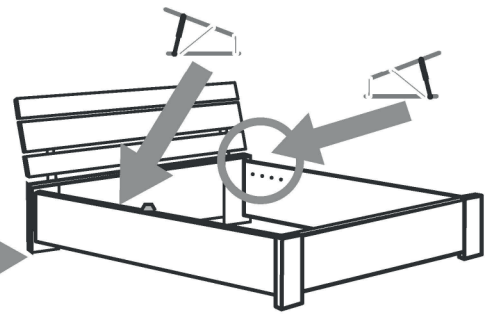
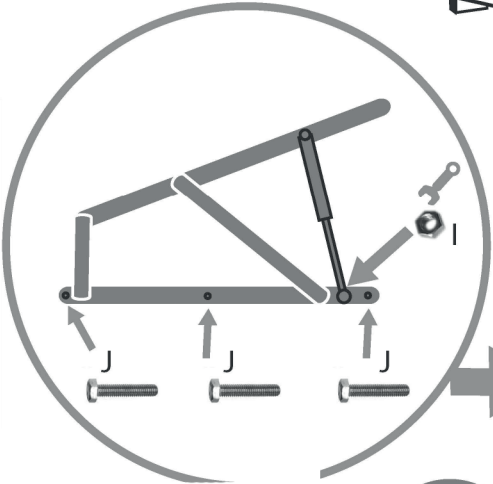

5

Stelaż Multi Box  
Montaż zgodnie z instrukcją  
znajdująca się wew. opakowania stelaża

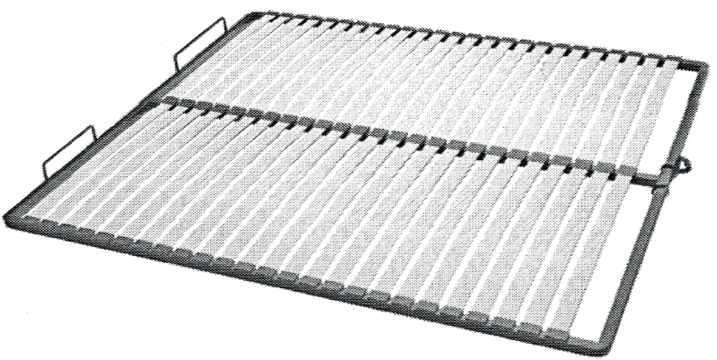

6

