

OLIN

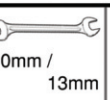

BED WITH STORAGE

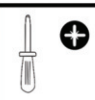
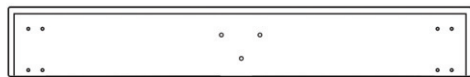
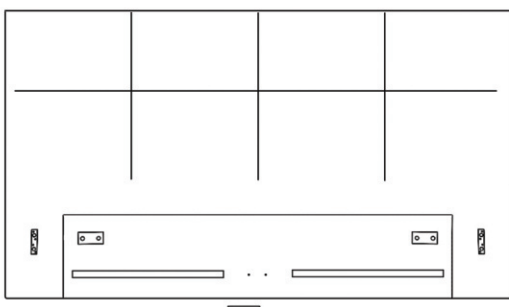
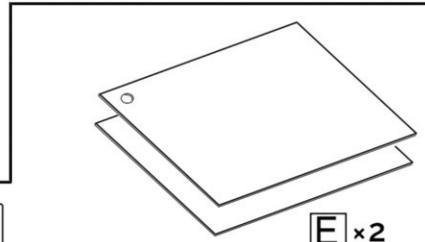
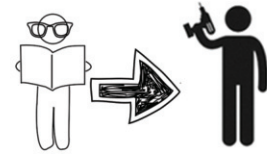
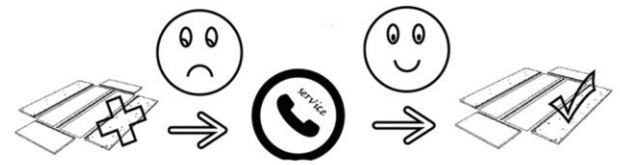

B x 1

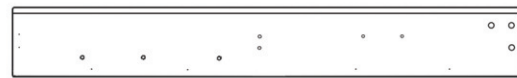

C₁ x 1

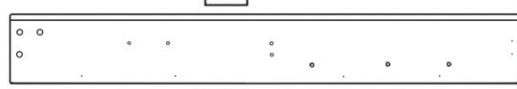

C₂ x 1

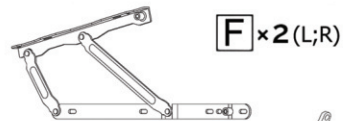

F x 2 (L;R)

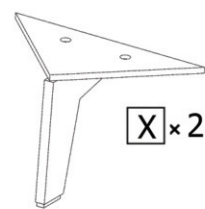

X x 2



Z₂ x 2

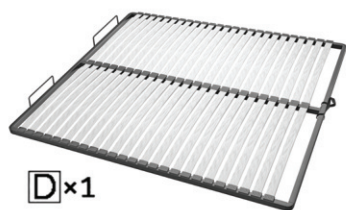

D x 1



G x 1

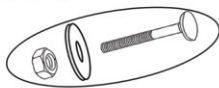

Y x 4

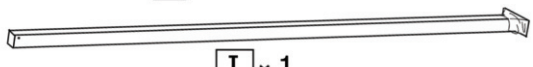

I x 1

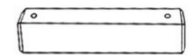









H x 3

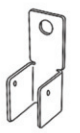
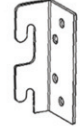
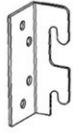

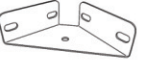
J x 3

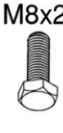

Z x 4

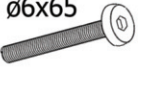
-  K x 1
-  W x 2
-  L x 2
-  M x 2
-  N x 2
-  O x 14
-  P x 9
-  R x 32
-  S x 1
-  T x 20
-  U x 6

1

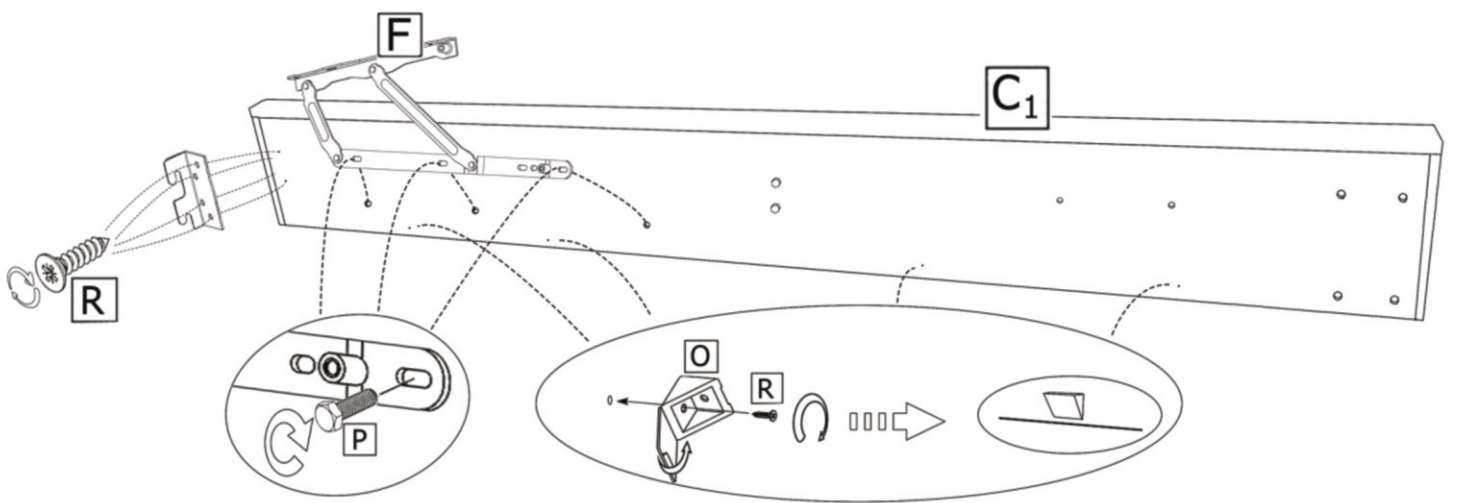

2

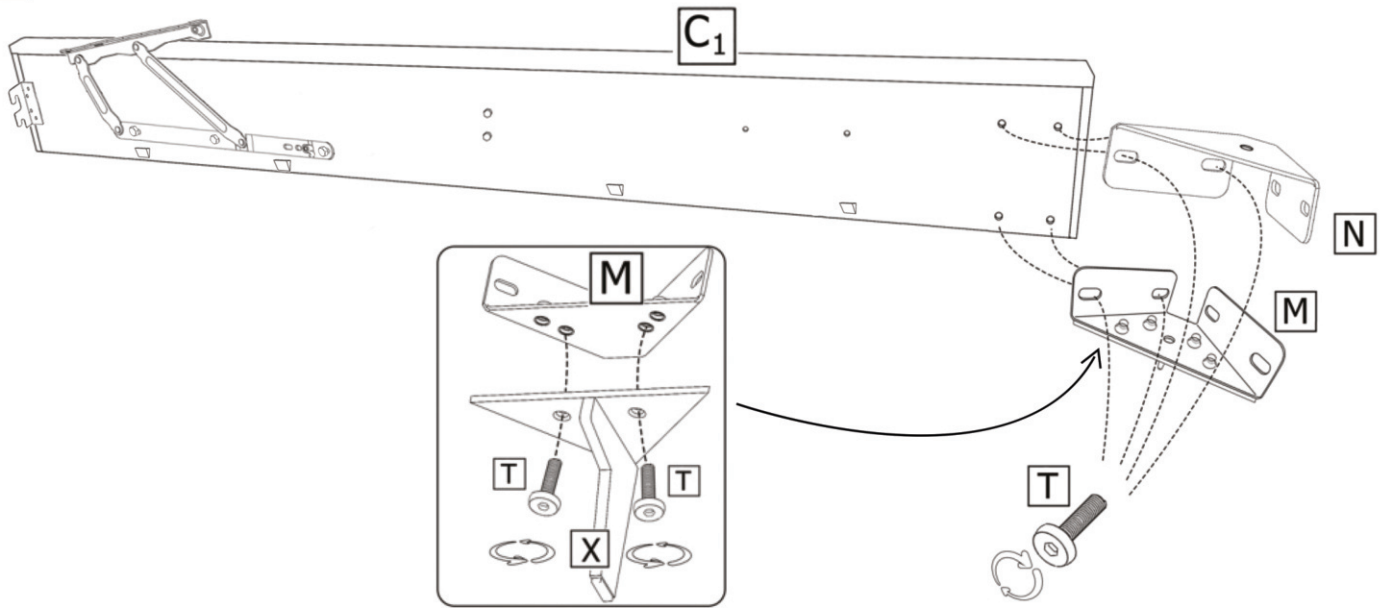

3

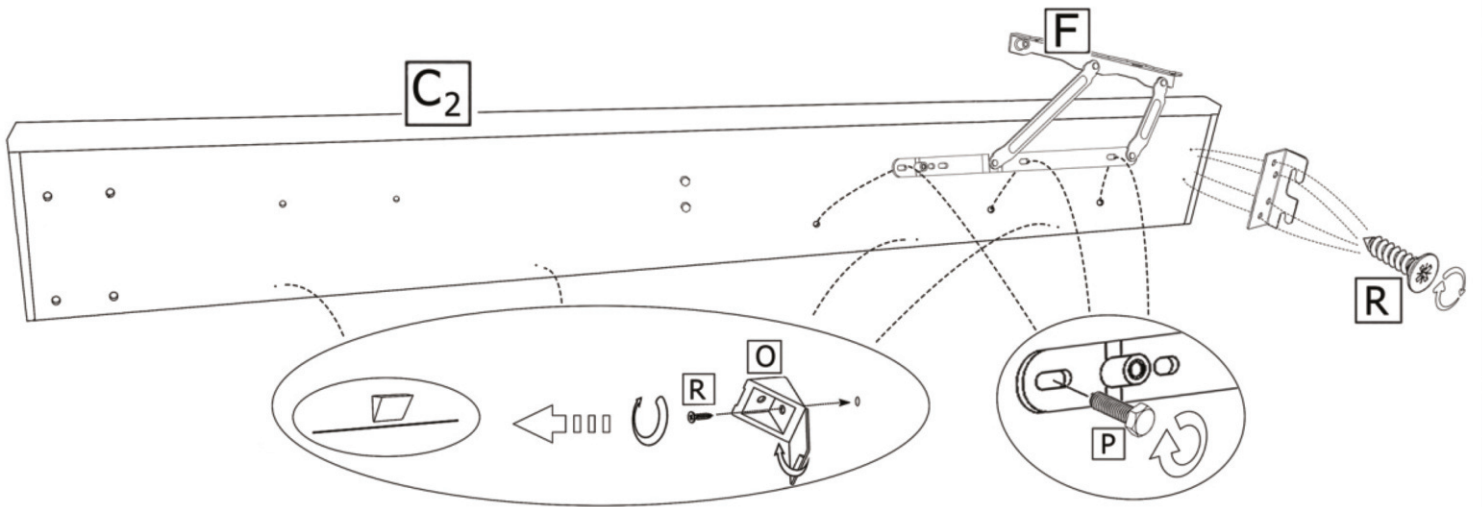

4

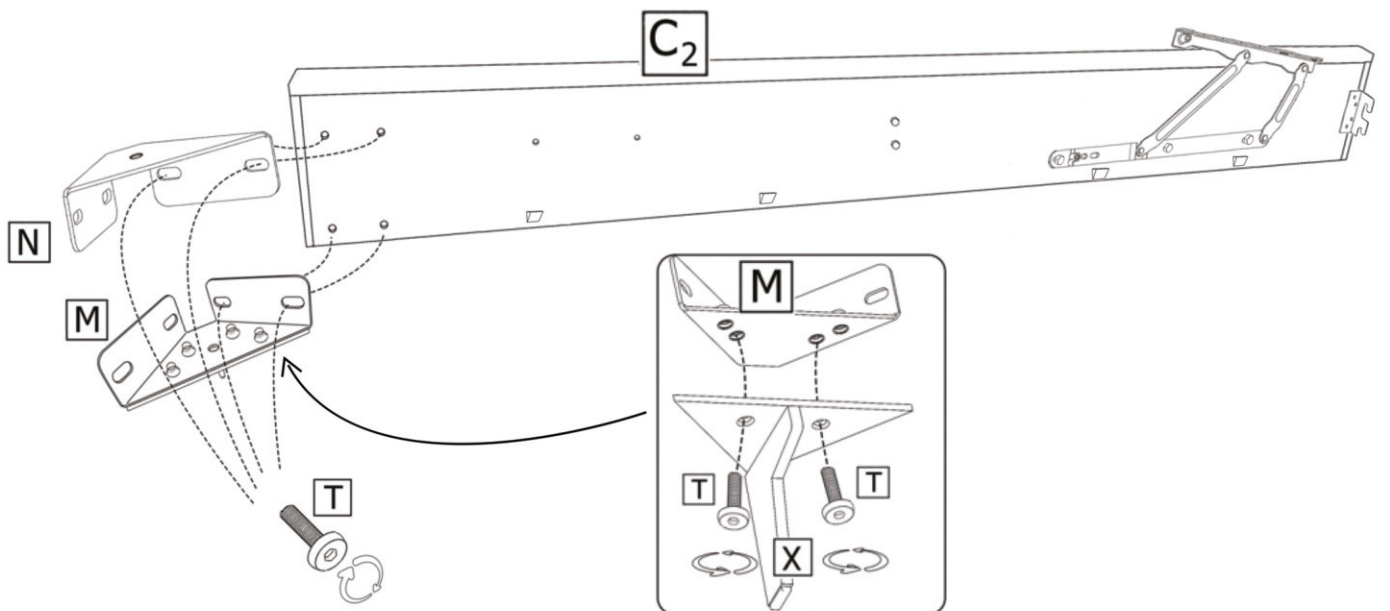

5

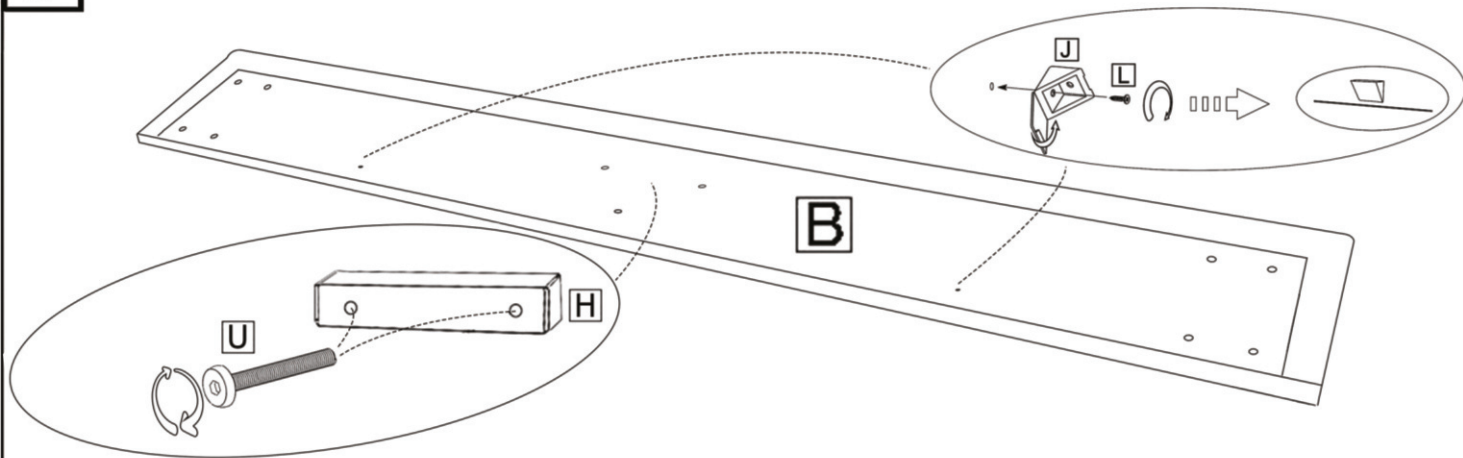

6

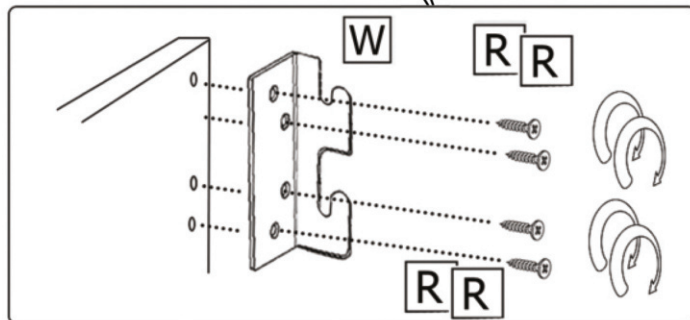
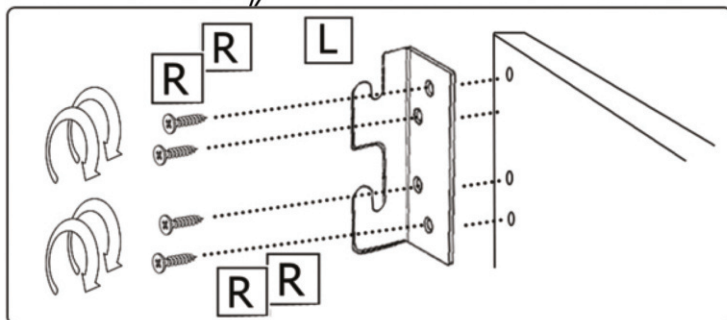
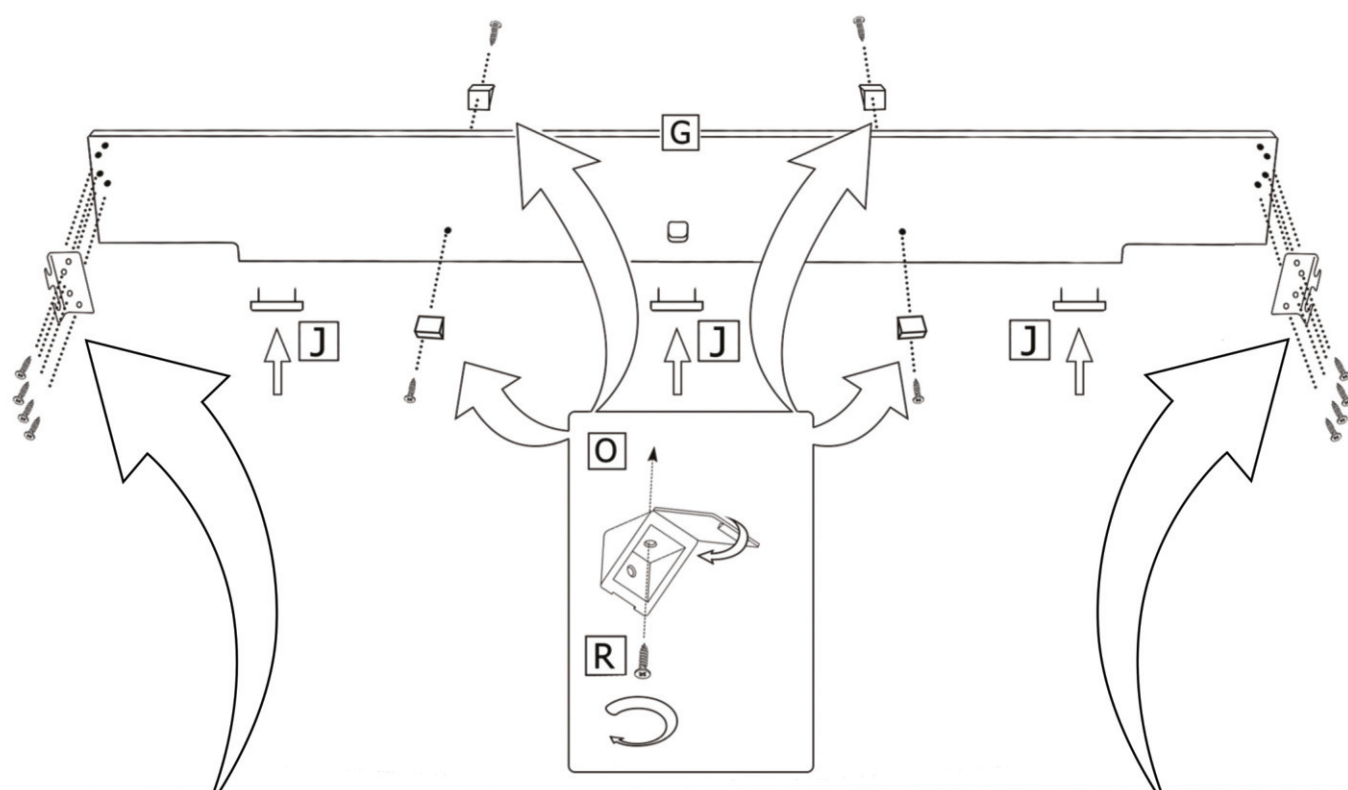

7

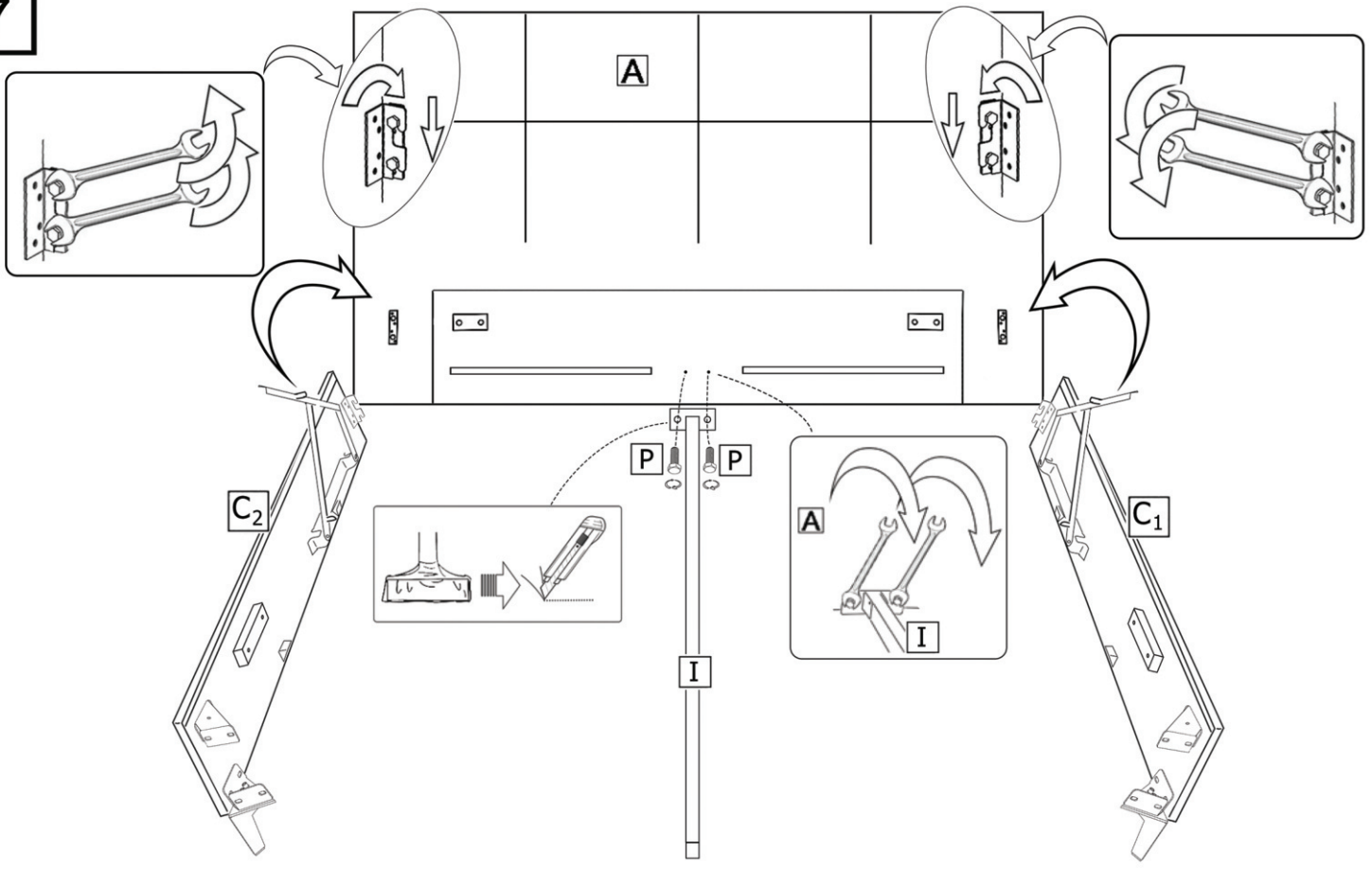

8

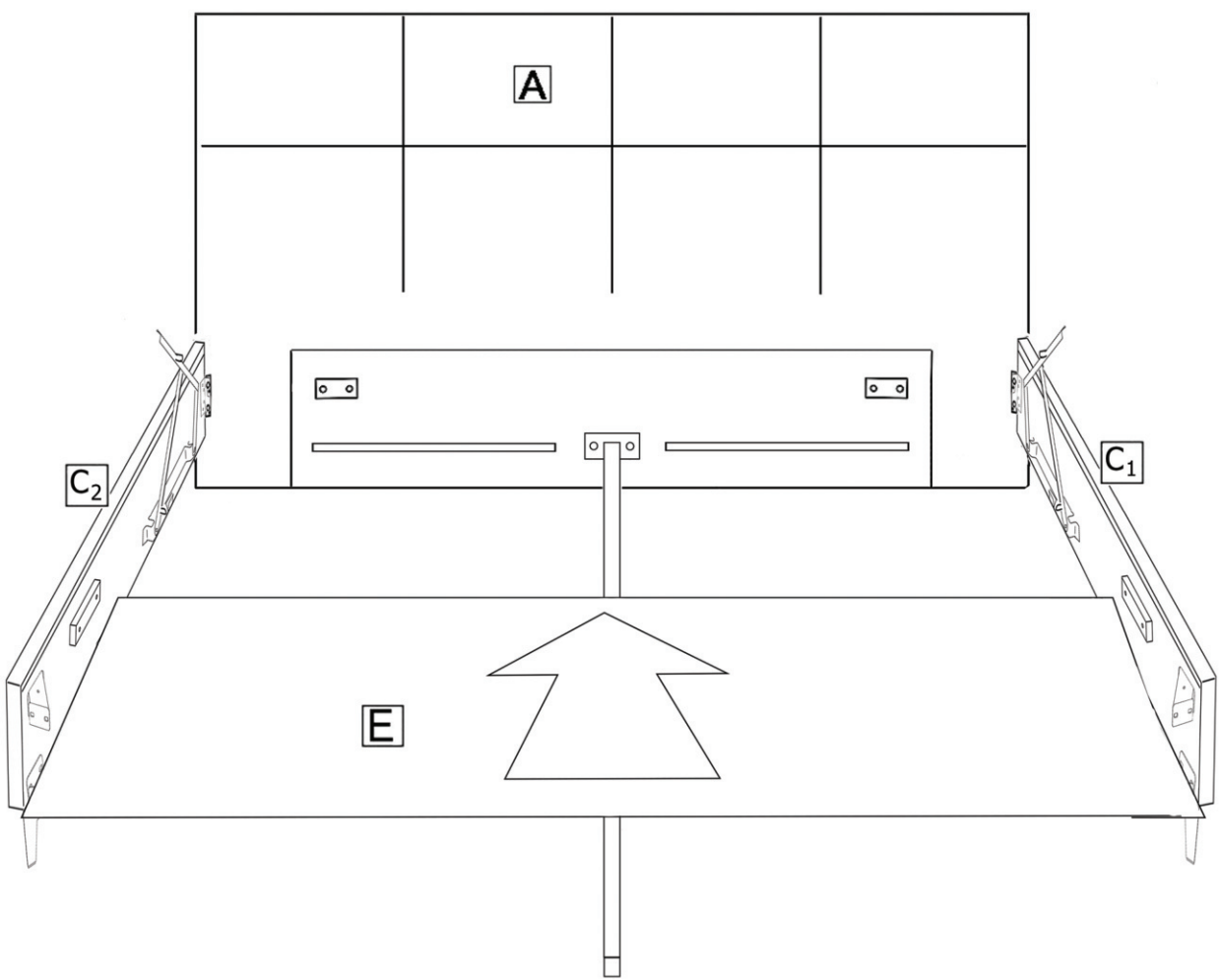

9

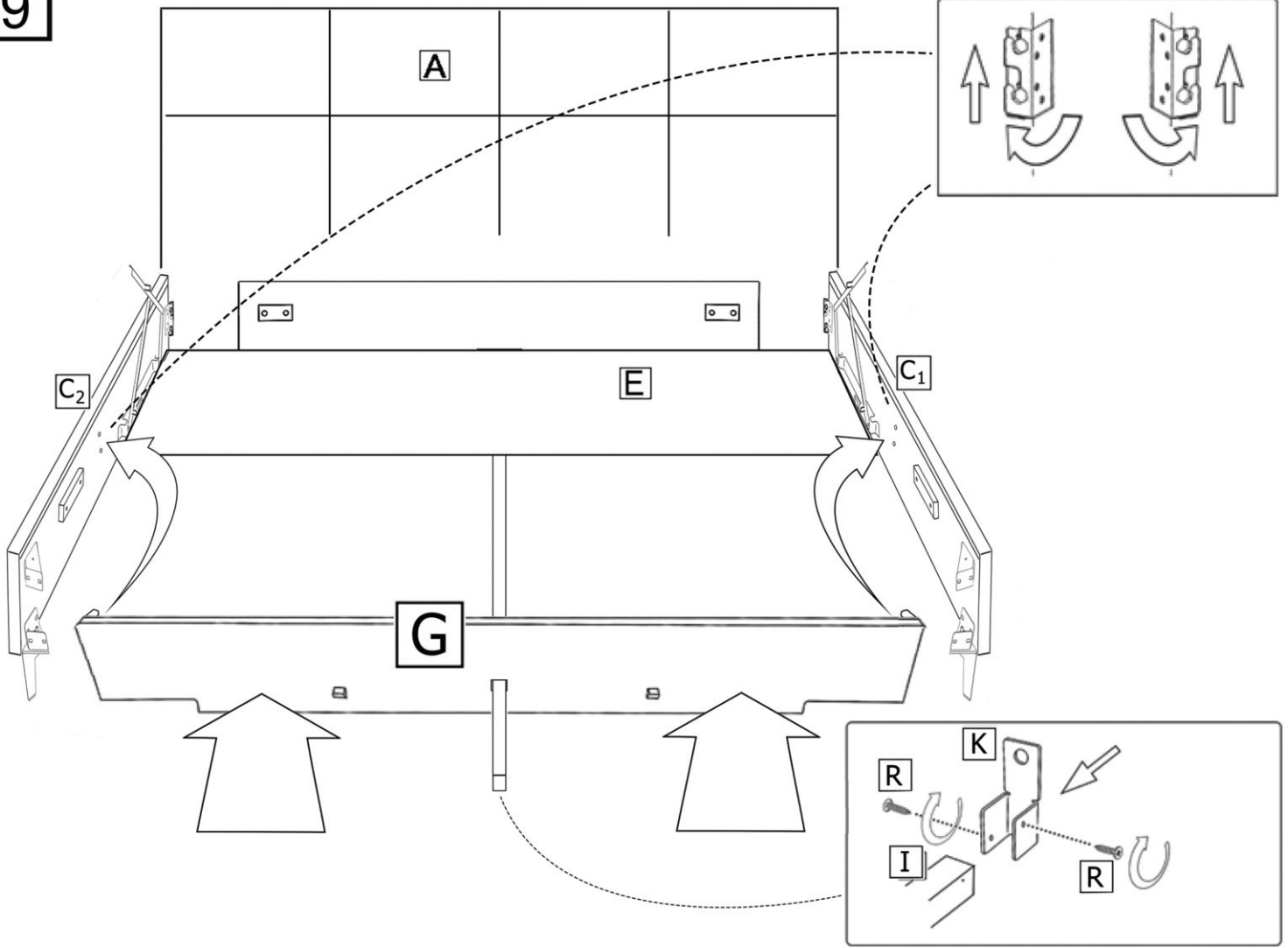

10

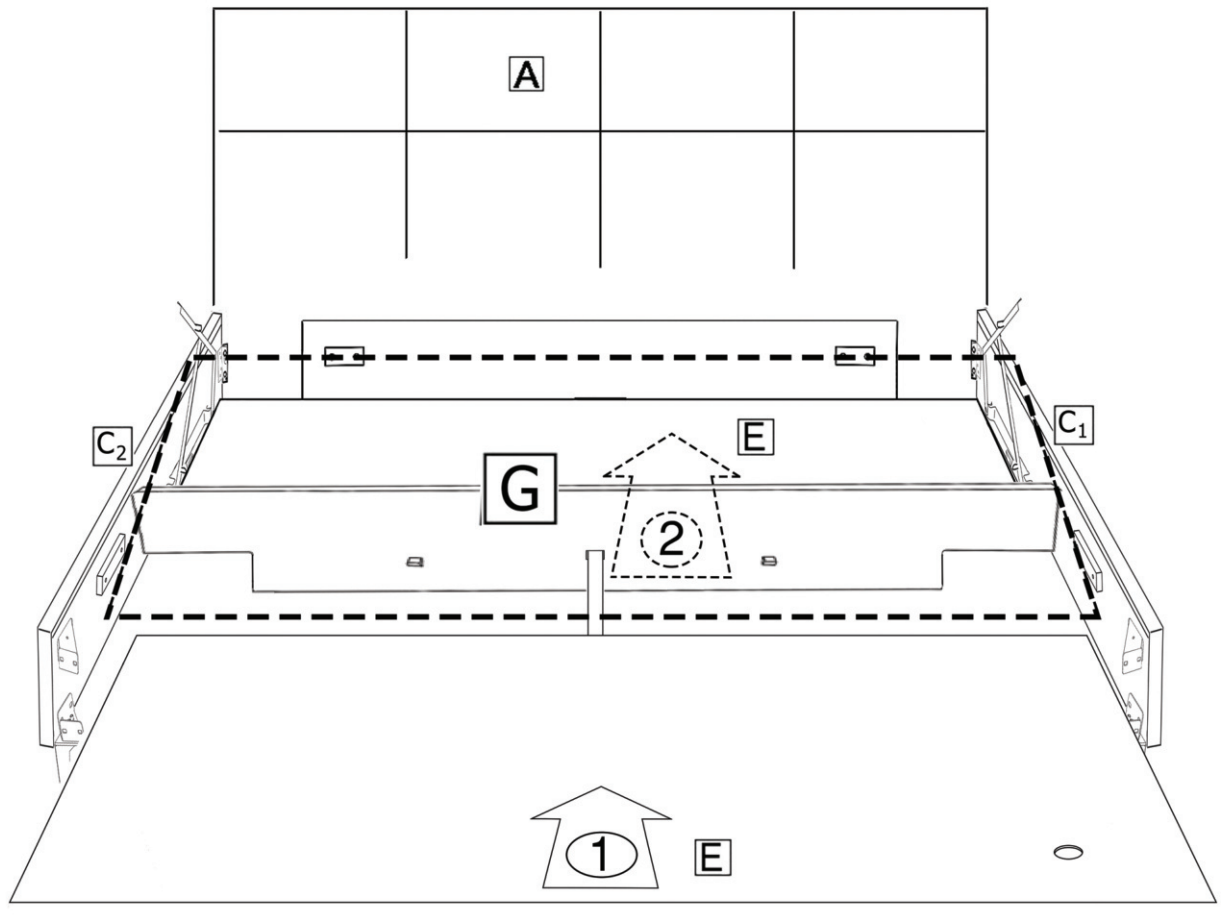

11

1

2

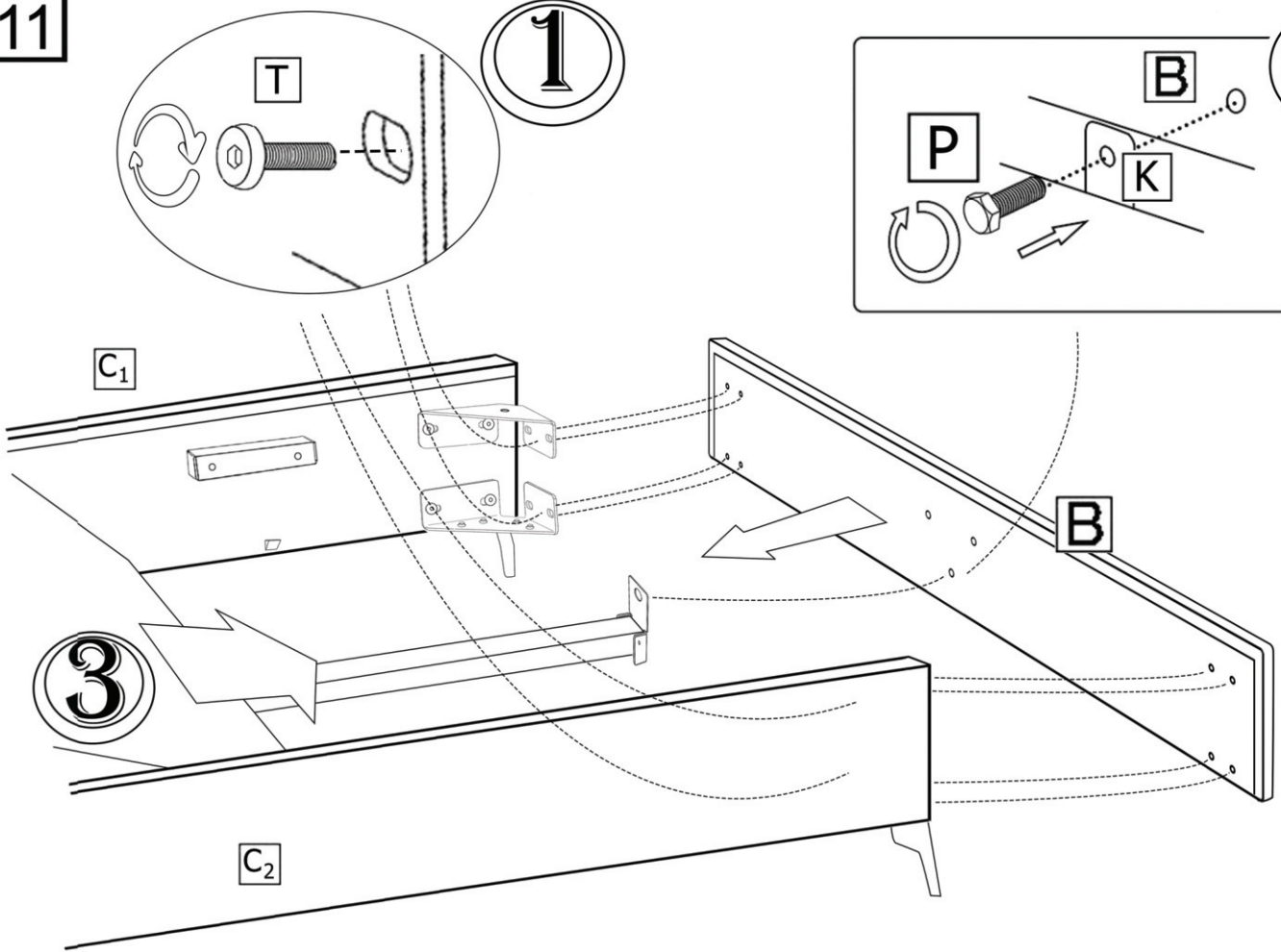

12

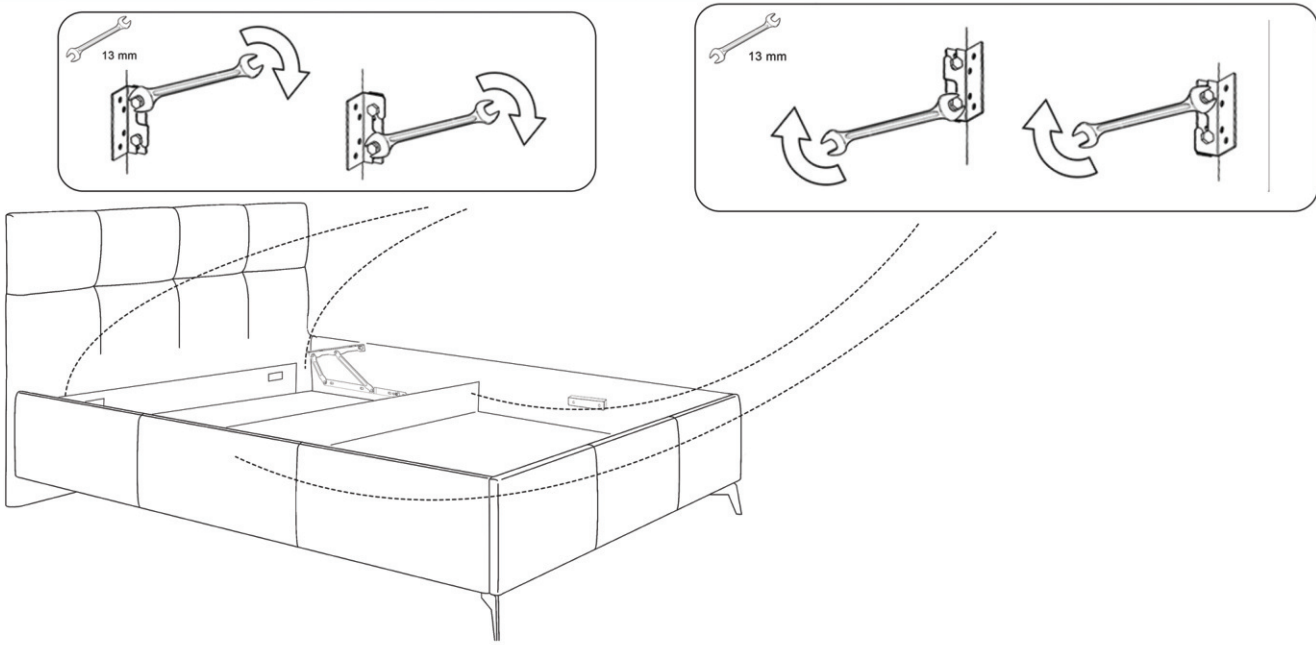

13

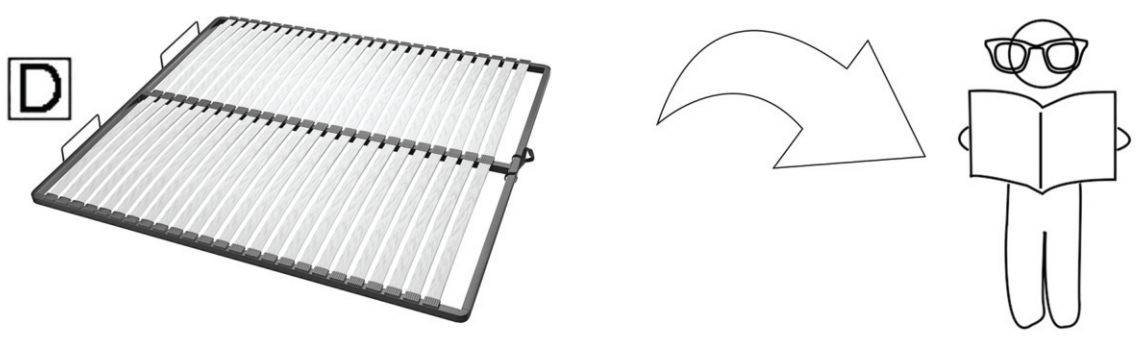

14

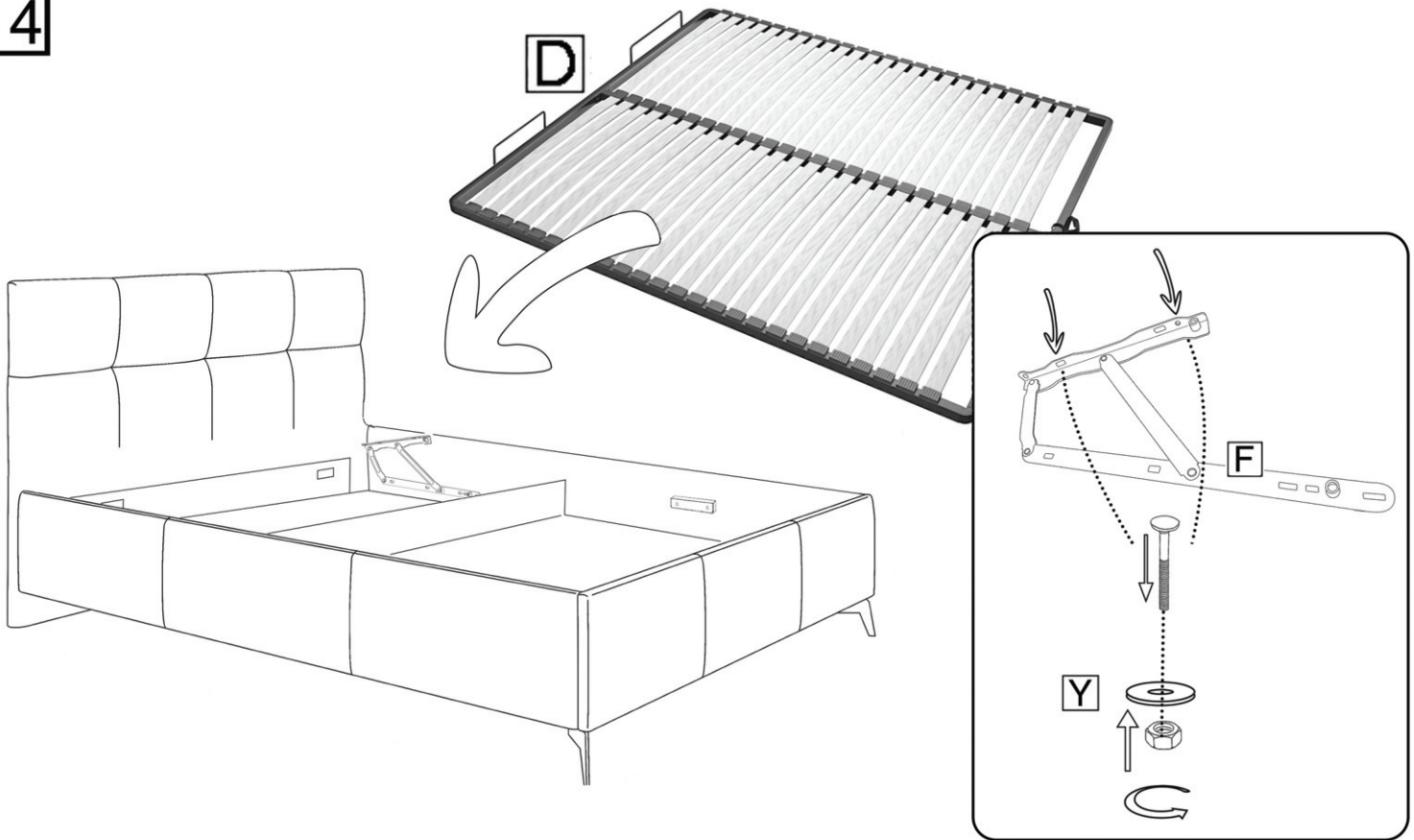

15

